

INSTRUCTION MANUAL

ROTEX ONE / LITE / PRO v2



S.E.F.A[®]
Z.I PASTABRAC
11260 ESPERAZA
FRANCE

Tel: +33 (0)4.68.74.05.89 - **Fax:** +33 (0)4.68.74.24.08

E-mail: contact@sefa.fr

INDEX

I.	WARRANTY TERMS	3
II.	WEAR PARTS	4
III.	OVERVIEW	5
IV.	OPERATING THE MACHINE	6
A.	SAFETY	6
B.	INSTALLATION	7
	Unpacking.....	7
C.	OPERATING CYCLE	8
D.	CONTROL PANEL	8
E.	OPERATION	8
1.	Setting the pressing time and temperature	9
2.	Pre-heat cycle	9
3.	Cycle Stop.....	9
4.	Programming a cycle	9
5.	Selecting a programme	10
6.	Item counter	10
7.	Alerts	10
F.	ADJUSTING THE HEIGHT OF THE HEAT PLATEN (PRESSING FORCE)	11
V.	MAINTENANCE	12
VI.	TROUBLESHOOTING TIPS	12
VII.	WIRING DIAGRAM	14
VIII.	SERVICING	15
IX.	MAINTENANCE LOG	16

I. WARRANTY TERMS

- The warranty period shall come into effect on the day on which the equipment is brought into service at the user's premises, as attested on the returned warranty certificate and the delivery note, and shall run for two years, based on a standard equipment operating schedule of 8 hours per day, i.e. 3,000 hours.
- The warranty is strictly limited to our equipment, and covers faulty materials and workmanship, which the purchaser shall be required to substantiate.
- Our liability shall be limited to making good or replacing free of charge parts that are acknowledged by us to be defective, and no claims for damages for any reason may be made against us.
- Parts replaced under warranty shall:
 - remain our property
 - be invoiced on consignment
- A credit note will be issued upon return of the faulty parts.
Returns must be made **NO LATER THAN ONE MONTH** after the work is performed under warranty.

THIS WARRANTY DOES NOT COVER:

- Commercially sourced wearing parts, material and equipment such as:
 - Fuses, bulbs, seals, hoses, nozzles, filters, etc.
 - Material and equipment not manufactured wholly by us, which are covered by the warranty of the manufacturer thereof.

THIS WARRANTY DOES NOT EXTEND TO:

- Replacements or repairs arising from fair wear and tear of the appliances or machines, damage or accidents arising from negligence, lack of supervision or maintenance, improper use or alterations made without our written consent.
- Defects arising from material provided by the purchaser or mandatory design requirements issued by the purchaser.
- Repairs made necessary by damage or accidents arising during carriage.
- Normal maintenance and adjustment procedures required during use of the machine, as set out in the maintenance instructions, such as:
 - adjustment of intermediate components
 - tightening of pipes, hoses, etc.



Any traces of detergent oil in the air system of pneumatic machines shall invalidate the aforementioned warranty terms.

**Quote the machine reference and serial number
when making technical enquiries or ordering spare parts.**

	ROTEX ONE / LITE / PRO V2
Weight in working order	68Kg
Height	674 mm
Depth	947 mm
Width	569 mm
Platen size	400 x 500 mm
Power supply	230 V Single phase + Earth 50/60 Hz
Power consumption	2500W (ONE & LITE Version) / 3200 W (PRO Version)
Amp rating	11A (ONE & LITE Version) / 14 A (PRO Version)
Electronic temperature controller	
Accuracy	+/- 1 %
Setting range	0 to 250 °C
Electronic timer	
Accuracy	+/- 1%
Setting range	0 s to 30 min
Adjustable pressure	0 to 0.6 daN/cm ²
Output	80 pieces/day

Non-contractual document: we reserve the right to alter our product specifications in line with advances in technology.

II. WEAR PARTS

When ordering: always quote the description, reference and quantity

Reference	Description	Quantity
CAR-CO2	ELECTRONIC BOARD	1
RES-500X400-3200W	MICA HEATING ELEMENT 400x500 2500 W ROTEX	1
SON-189	LUG-MOUNTED TEMPERATURE PROBE	1
FIN-231	REED TYPE LIMIT SWITCH	1
MOU-540	SILICONE FOAM 400X500 mm	1
RES-BI2	GAS-OPERATED SPRING	2
VEN-300	230 V 7 W ELECTROMAGNETIC AIR VALVE	1
FUS-153	16 A FUSE	2

III. OVERVIEW

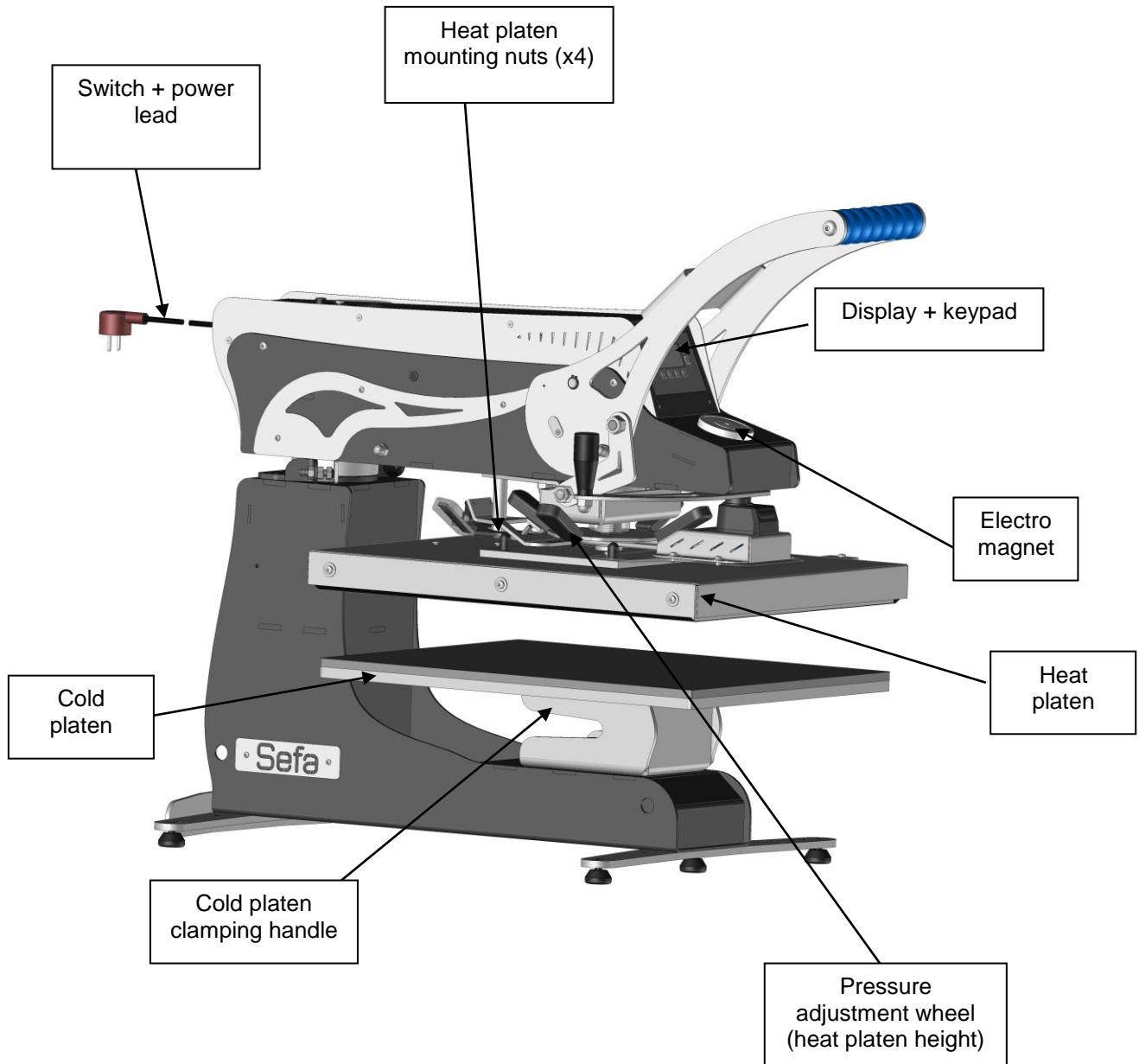

This heat press complies with the operator safety requirements of article L 233-5 of the French labour code.

It has been designed to operate at a high rate of output with unfailing reliability.

It has been designed for use by a single operator positioned in front of the machine.

IV. OPERATING THE MACHINE

The ROTEX is designed to apply transfers of any quality in small and medium batches.
This equipment has been factory-tested by us to offer a two-year warranty against manufacturing defects.

The factory-installed electrical and mechanical settings programmed by our technicians and the safety features must not be altered under any circumstances. **S.E.F.A**[®] accepts no liability for problems that may be caused by the machine if such alterations are made.

Please read the safety instructions and the operating manual carefully before operating the press.

The press should be operated by a qualified person who is aware of the potential dangers arising from improper use of the equipment.

A. SAFETY

THIS MACHINE IS DESIGNED FOR USE BY A SINGLE OPERATOR



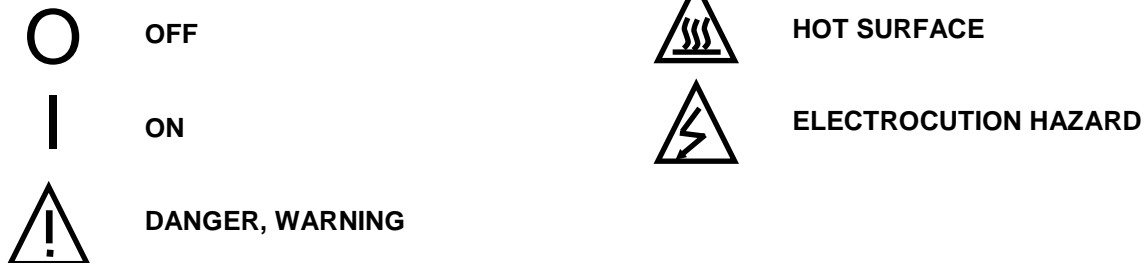

FOR USE BY QUALIFIED PERSONNEL

International symbols:



Most of these symbols appear on SEFA machines.

Important user safety precautions:

-  ***Do not touch hot parts of the machine during use.***
-  ***Make sure the operator is not exposed to risks of burns, electrocution or other hazards when handling the machine.***
-  ***Check the machine each day before use.***
-  ***Make sure there is nobody in the vicinity of the machine before starting work.***
-  ***If the machine malfunctions, cut the power supply and look for the cause of the problem in the Servicing section of the manual.***

Safety features:



***No changes must be made to the safety systems. They must be refitted if they are removed for servicing work.
They must be held securely in place and kept in good condition during normal use.***

The ROTEX LITE press is operated by hand. As such, the operator is responsible for any risks taken.

B. INSTALLATION

TO BE PERFORMED BY QUALIFIED PERSONNEL



***Do not hold the machine by the platens!
Carry the machine using the handles provided***

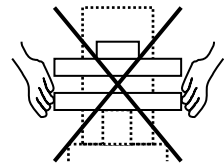

Unpacking

- Remove the packing case.
- Use a 10 mm spanner to remove the four bolts holding the machine to the packaging.
- Lift the press on to its work table using the carry bars provided.
- Fit the leg extension as shown on the photo below.
- Attach the machine to its work table.
- Remove the HSHC screw used to hold the press in the working position in transit.
- The press will rise to the at-rest position.
- Plug in the press (230 Volt + Earth / 50 or 60 Hz).

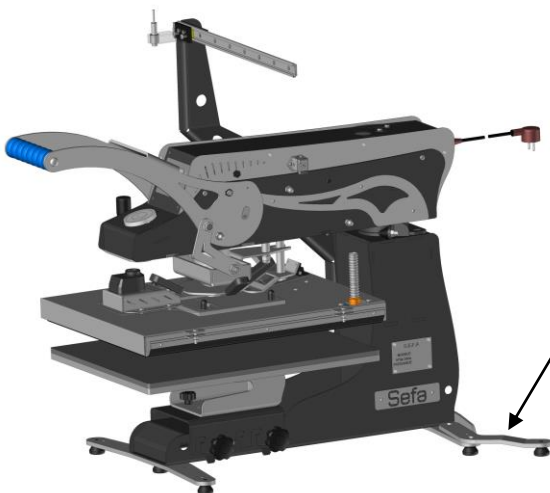

**MONTER LA RALLONGE PIED AVANT
DE RETIRER LA VIS D'EMBALLAGE
MOUNT EXTENSION FOOT BEFORE
REMOVING THE TRANSPORT SCREW**

C. OPERATING CYCLE

1. Press the main switch at the back of the frame to turn the power on. The screen will come on and display a welcome message followed by the factory settings.
2. Use the keypad to adjust the temperature to suit the type of transfer.
3. Use the keypad to set the pressing time to suit the type of transfer.
4. Adjust the pressure using the adjustment wheel on the heat platen.
5. Place the work item on the lower platen.
6. Position the transfer sheet correctly.
7. Pull the handle down to lower the heat platen into position.
8. The timer will start when the platen is pressed against the work item.
9. The buzzer will sound when the timer has finished to indicate that the platen is about to lift open.
10. The heat platen will lift open automatically (LITE & PRO VERSION)
11. Repeat from step 5 above to continue with the same settings, or from step 2 to apply new settings.

D. CONTROL PANEL

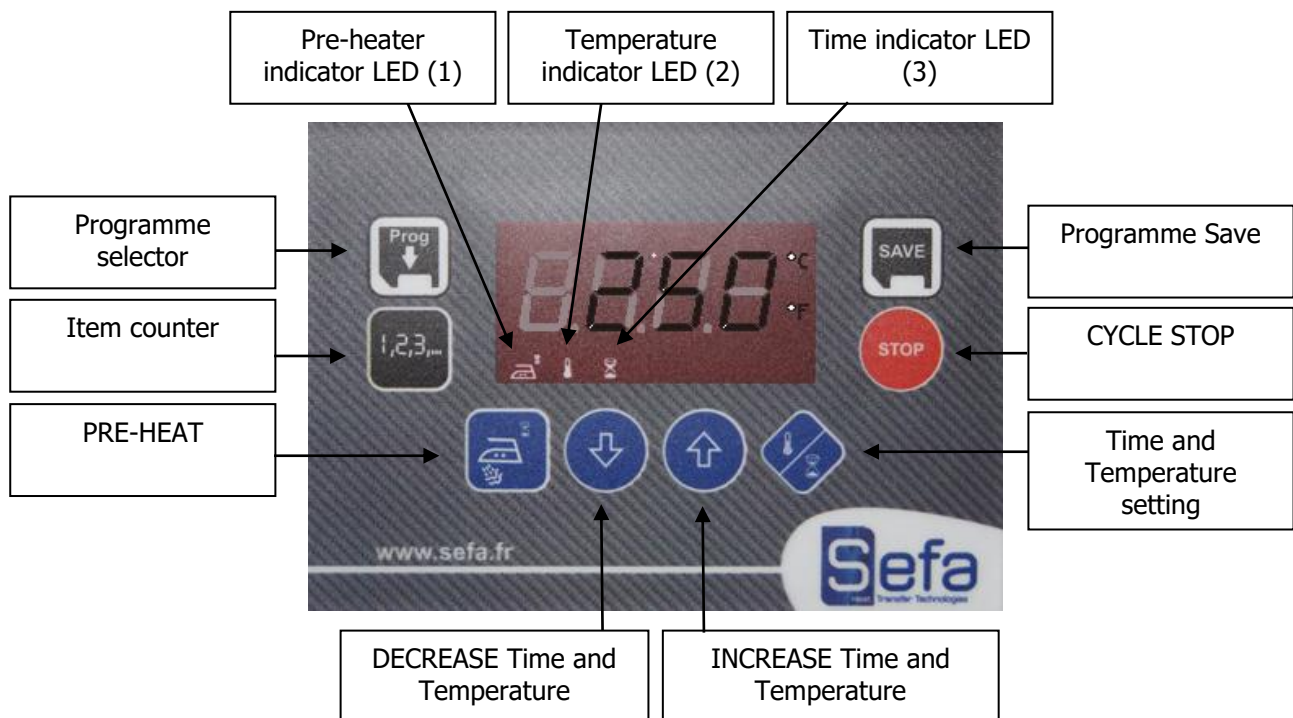

E. OPERATION

1. Setting the pressing time and temperature



a) Pressing time

Press the TIME/TEMPERATURE key . Indicator ③ will flash: you can now set the pressing time. The default factory setting is 15 seconds.

Use the UP  and DOWN  keys to alter this setting.

Press the TIME/TEMPERATURE  key again to confirm the new setting. You can now set the pressing temperature.

b) Temperature

Indicator ② will flash when you have finished setting the pressing time: you can now set the pressing temperature. The default factory setting is 180° C.

Use the UP  and DOWN  keys to alter this setting.

Press the TIME/TEMPERATURE  key again to confirm the new setting. The press is now ready to apply the transfer.

2. Pre-heat cycle



The press includes a 2nd timer that lets you pre-heat the fabric for a set time before positioning the transfer.

a) Setting the pre-heat time

Press the PRE-HEAT key ; indicator ① will begin to flash.

Use the UP  and DOWN  keys to alter the setting.

Press the PRE-HEAT key  again to confirm the new setting.

The pre-heat cycle will not run when set to 0 (factory setting).

b) Use

Place the fabric on the platen without a transfer.

Close the press: the 2nd timer will start and indicator ① will come on. The buzzer will sound at the end of the set time and the press will open automatically.

Place the transfer on the fabric and close the press again.

The main timer will start and indicator ③ will come on. The press will open automatically when the countdown has finished.

NB: the pre-heat temperature is the same as the indicated transfer setpoint.

3. Cycle Stop

You can stop the cycle at any time by pressing the CYCLE STOP key . The press will open automatically and the timer will stop.

4. Programming a cycle



Up to 3 programmes can be stored with different settings:

- Pre-heat time
- Main time
- Temperature

Press the SAVE key  to store the most recent press settings.
The name of the programme you are trying to save (Pr1, etc) will flash on the display.

Keep pressing the SAVE  key to scroll through the programme names to the name you want (Pr1 → Pr2 → Pr3 → Pr1 etc)

Press and hold the SAVE key  for 3 seconds to save the programme.
The buzzer will sound when the programme has been saved successfully.

The default factory settings for the 3 programmes Pr1 to Pr3 are:

- 180° C for the temperature
- 15 seconds for the main time
- 0 seconds for the pre-heat time

5. Selecting a programme



Press the SELECT key  to retrieve a saved programme. The last used programme will be displayed.
Keep pressing the key to bring up the required programme.

Keep the SELECT key  pressed in for 3 seconds to confirm your selection.
The buzzer will sound when the programme has been confirmed.
The selected programme's temperature setting, pre-heat time and main pressing time will be loaded automatically.

6. Item counter



The press features two item counters:

- A resettable partial counter
- A non-resettable total counter

a) Partial counter

Press the COUNTER key  once to see how many cycles that have been successfully completed since the last reset. Display lasts 5 seconds.
Press and hold the key for 3 seconds to reset the counter.

b) Total counter

Press the COUNTER key  twice to see how many hundreds of press cycles have been completed in total (e.g. 230 means 23,000 items).
This counter cannot be reset.

The screen will return to the normal display after 3 seconds.

7. Alerts

On-screen message	Cause	Effect
Er1	Faulty temperature probe	Heating relay disabled
Err	Faulty card probe	Heating relay disabled
Col	Keypad-base connection alarm	Relay disabled

Each alert sets off the buzzer, which can be muted by pressing any key.

F. ADJUSTING THE HEIGHT OF THE HEAT PLATEN (PRESSING FORCE)

The pressure applied by the heat platen can be altered to suit operator requirements. The cold platen can also be fully lowered to leave a gap between the two platens (maximum distance in the working position: 15 mm).

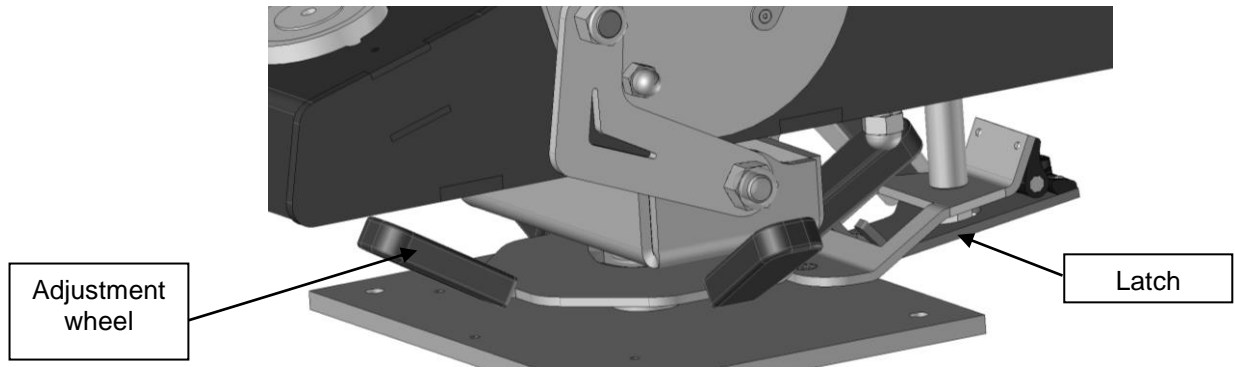

- a) Release the latch.
- b) Turn the adjustment wheel clockwise to lower the heat platen (and increase the pressing force).
- c) Turn the other way to reduce the pressure.
- d) An optional position indicator shows the height and therefore the pressure setting.
- e) Re-attach the latch once the pressure has been adjusted.

G. AUTO SWING (PRO VERSION)

- 1) Rotate the head of the machine at the maximum at the right

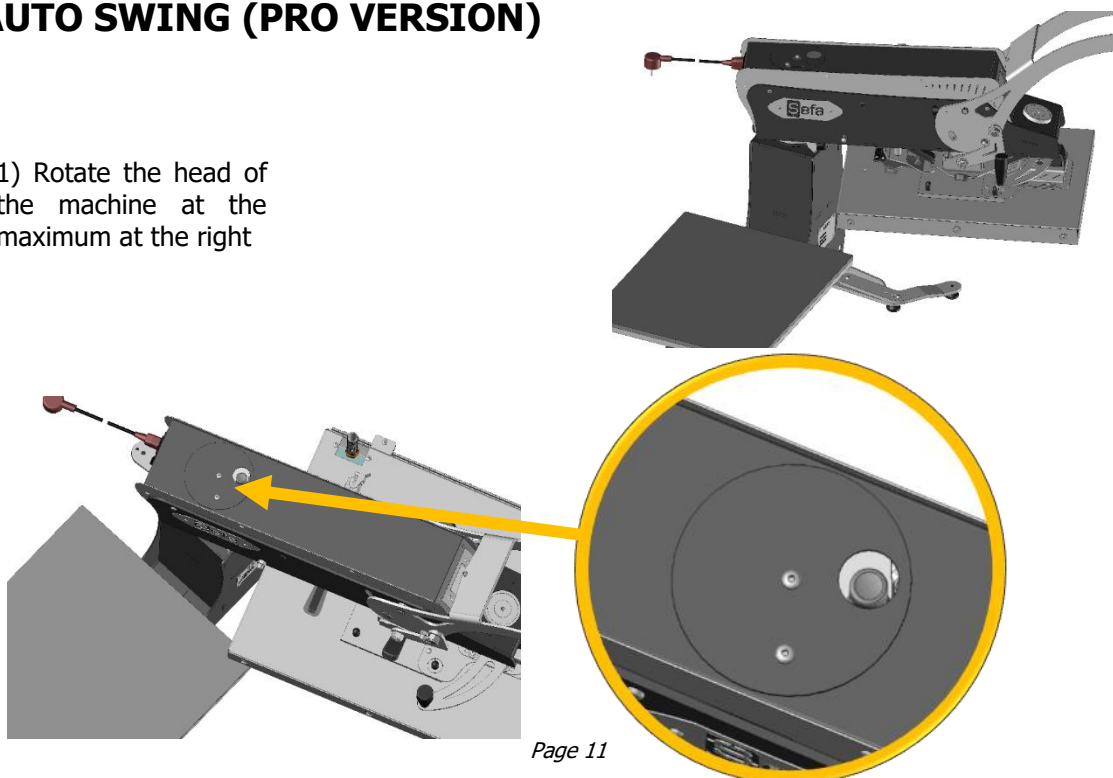

2) To activate the autoswing system, rotate the cover (1 on the picture) and push the button (2 on the picture)

3) To deactivate the autoswing system, rotate the head of the machine at the maximum at the right, rotate the cover (1 on the picture) and push the button (2 on the picture)

V. MAINTENANCE

- Daily:
 - ↪ Clean the heat platen with a dry cloth.
- According to use:
 - ↪ Replace the silicone foam pad at the first sign of damage or deterioration in quality.

VI. TROUBLESHOOTING TIPS



The machine's electrical power must be switched off and locked and tagged prior to any service repair work.

The heat platen can cause burns. Check that the platen temperature reading on the display panel is below 25° C before handling.

TO BE PERFORMED BY QUALIFIED PERSONNEL

PROBLEM	POSSIBLE CAUSES	SOLUTION
The machine does not switch on	<ul style="list-style-type: none"> ➤ The plug is not connected ➤ The switch has not been pressed ➤ Main fuse not working 	<ul style="list-style-type: none"> ➤ Check the mains electricity and that the machine is plugged in. ➤ Press the main On/Off switch to 1. ➤ The fuse is located in a holder next to the plug. It can be reached by removing the power lead and prising up the housing with the tip of a screwdriver. The square tube contains a spare fuse to replace the one in the clip.
The platen does not heat up	<ul style="list-style-type: none"> ➤ Faulty heating element ➤ Problem with the electronic board ➤ Temperature setting too low 	<ul style="list-style-type: none"> ➤ Check the connections and the condition of the wires. Contact your retailer to have the platen removed. ➤ Check the on-screen messages and refer to the board user manual. ➤ See section V about changing this setting
The platen overheats	<ul style="list-style-type: none"> ➤ Problem with the probe or the electronic board 	<ul style="list-style-type: none"> ➤ Check the on-screen messages and refer to the list of error messages. Contact your stockist.

<p>The timer does not count down</p>	<ul style="list-style-type: none"> ➤ Disabled or faulty limit switch on the swing arm ➤ Problem with the electronic board 	<ul style="list-style-type: none"> ➤ Check the connections. ➤ Check the on-screen messages and refer to the board user manual.
<p>The platen does not lower</p>	<ul style="list-style-type: none"> ➤ The pins are stuck or too tight ➤ The gas-operated springs are stuck 	<ul style="list-style-type: none"> ➤ Lubricate or loosen the pins slightly. ➤ Check them but do not try to open them: parts under high pressure - Danger. Contact your stockist about a possible replacement.
<p>The platen stays down after pressing</p>	<ul style="list-style-type: none"> ➤ The gas-operated springs are stuck ➤ The timer is not counting down 	<ul style="list-style-type: none"> ➤ Leaking spring mechanism, pressure too low for the springs to lift the platen. Check them but do not try to open them: parts under high pressure - Danger. Contact your stockist about a possible replacement. ➤ See above.

VII. WIRING DIAGRAM

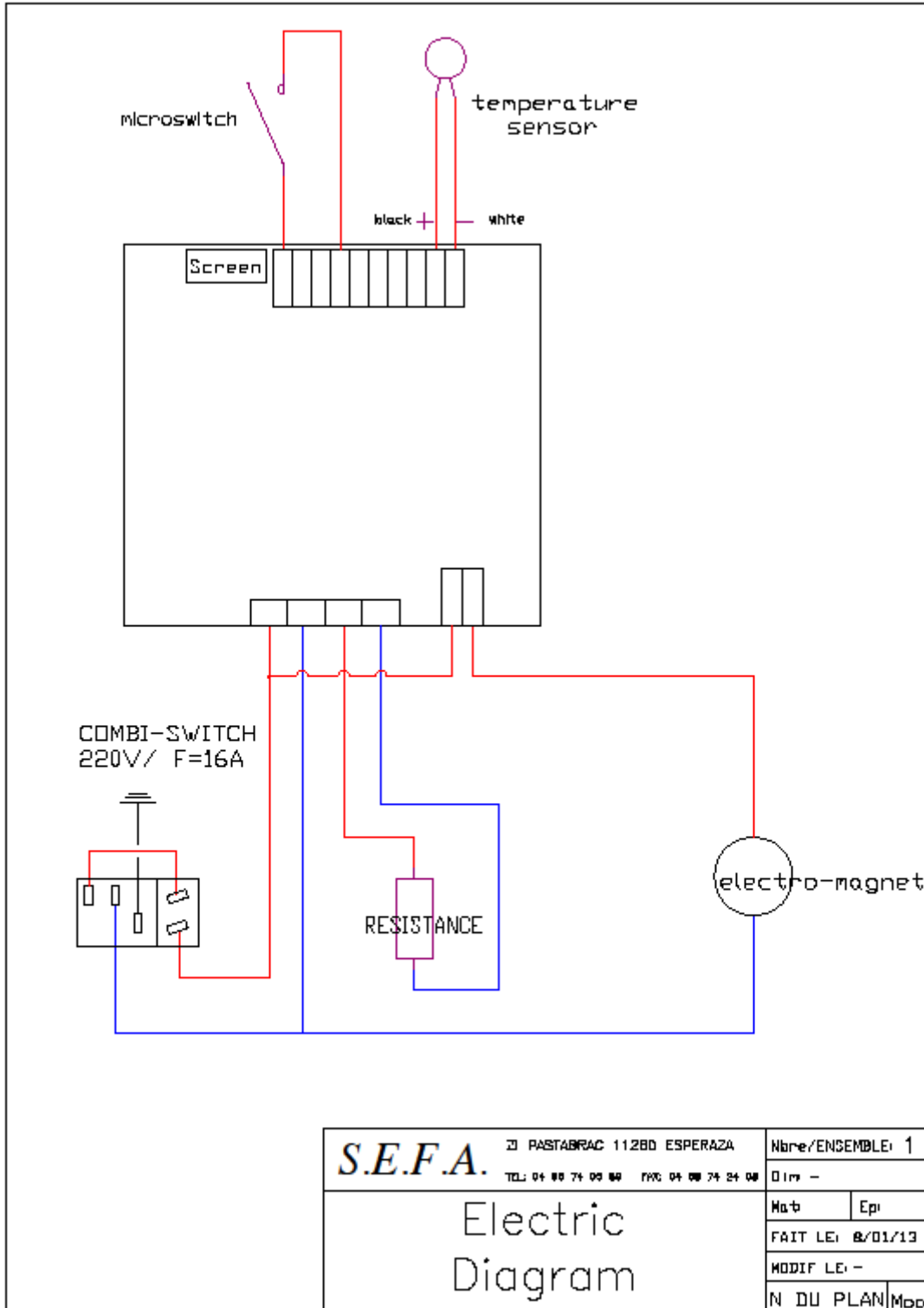

VIII. SERVICING

TO BE PERFORMED BY QUALIFIED PERSONNEL

THE MACHINE MUST BE SWITCHED OFF AND LOCKED AND TAGGED PRIOR TO SERVICING

(ELECTRICAL POWER SOURCE DISCONNECTED)

The following tools should be available at hand:

- Flat-blade screwdriver
- Phillips screwdriver
- Set of open-ended spanners and box spanners
- Small water pump pliers
- Circlip pliers
- Needle-nose pliers with insulated handle
- Set of Allen keys



Always make sure the temperature of the heat platen is below 25°C before handling.

IX. MAINTENANCE LOG

The following checks and maintenance procedures should be performed at regular intervals to ensure that your press remains in good working order and continues to provide reliable service.

Date	Number of hours	Pressure check	Air filter check	Cylinder check	Condition of foam pad	Heating element check	Replaced parts	Observations

Tip - use the following abbreviations to help complete the log more quickly:
C: Checked W: Washed/Cleaned R: Replaced